

American Roofing Products - Standing Seam

All trim can be custom folded to your specifications - see your sales representative.

AmeriLoc Nail Flange Standard Trim

Ridge Cap - Hip

- 26 GA
- 10'6" Standard Length
- 10 Standard Colors

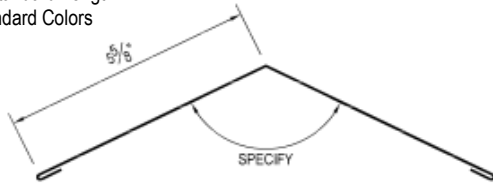

See following Flashing Angle Chart for Angle Guide

Flashing - Sidewall

- 26 GA
- 10'3" Standard Length
- 10 Standard Colors

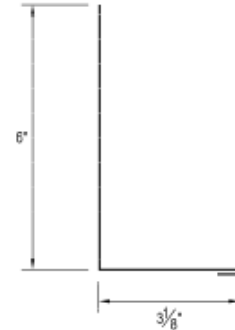

Ridge Cap - Stepped

- 26 GA
- 10'6" Standard Length
- 10 Standard Colors

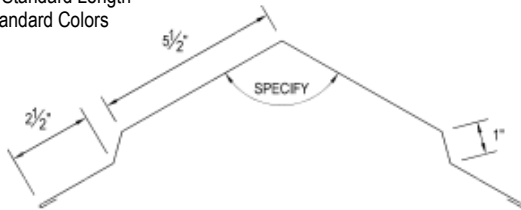

See following Flashing Angle Chart for Angle Guide

Flashing - Headwall

- 26 GA
- 10'3" Standard Length
- 10 Standard Colors

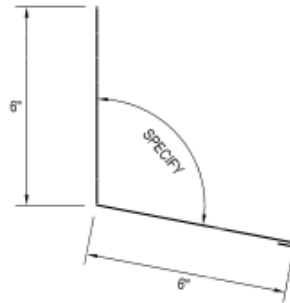

See following Flashing Angle Chart for Angle Guide

Valley - Preformed

- 26 GA
- 10'3" Standard Length
- 10 Standard Colors

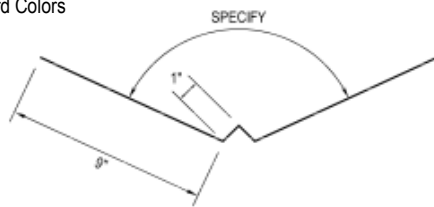

See following Flashing Angle Chart for Angle Guide

Flashing - Transition

- 26 GA
- 10'3" Standard Length
- 10 Standard Colors

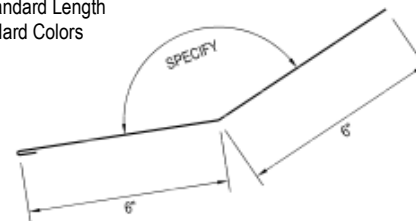

See following Flashing Angle Chart for Angle Guide

Rake - Standard

- 26 GA
- 10'3" Standard Length
- 10 Standard Colors

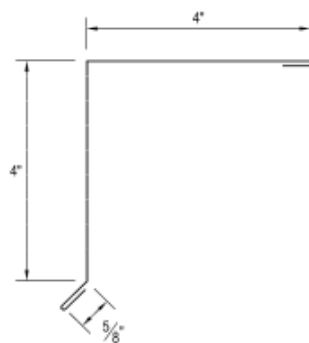

Flashing - Reglet

- 26 GA
- 10'3" Standard Length
- 10 Standard Colors

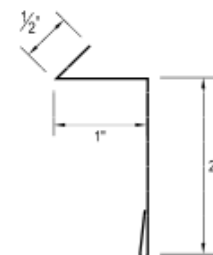



The difference in our Products is our Service

American Roofing Products - Standing Seam

All trim can be custom folded to your specifications - see your sales representative.

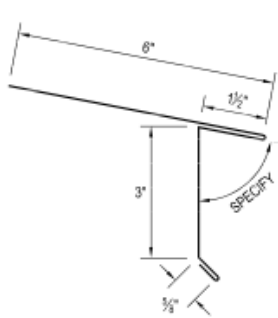
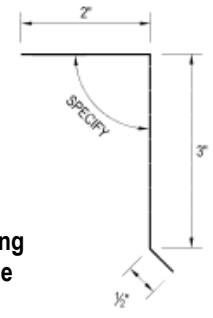
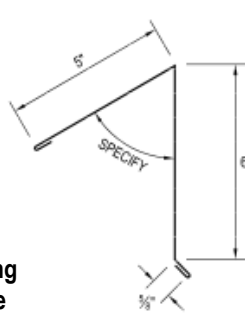
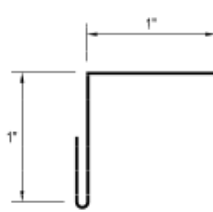
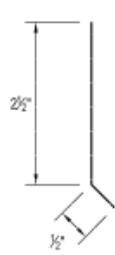
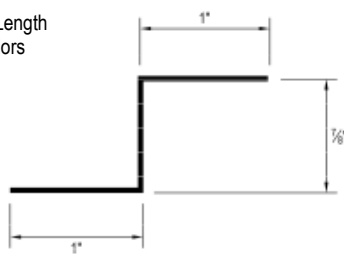
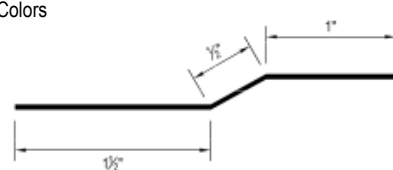
AmeriLoc Nail Flange Standard Trim

<p>Eave Drip - Extended</p> <ul style="list-style-type: none"> • 26 GA • 10'3" Standard Length • 10 Standard Colors  <p>See following Flashing Angle Chart for Angle Guide</p>	<p>Cleat - Cable Eave</p> <ul style="list-style-type: none"> • 26 GA • 10'3" Standard Length • 10 Standard Colors  <p>See following Flashing Angle Chart for Angle Guide</p>
<p>High Eave Trim</p> <ul style="list-style-type: none"> • 26 GA • 10'3" Standard Length • 10 Standard Colors  <p>See following Flashing Angle Chart for Angle Guide</p>	<p>Parapet Rake Cleat</p> <ul style="list-style-type: none"> • 26 GA • 10'3" Standard Length • 10 Standard Colors 
<p>Cleat</p> <ul style="list-style-type: none"> • 26 GA • 10'3" Standard Length • 10 Standard Colors 	<p>Z - Closure</p> <ul style="list-style-type: none"> • 26 GA • 10'3" Standard Length • 10 Standard Colors 
<p>Cleat - Offset</p> <ul style="list-style-type: none"> • 26 GA • 10'3" Standard Length • 10 Standard Colors 	<p>Outside Vent Closure</p> 

The difference in our Products is our Service



American Roofing Products - Standing Seam

All trim can be custom folded to your specifications - see your sales representative.

AmeriLoc-II Clip Attached Standard Trim

RIDGE CAPS & HIP CAPS

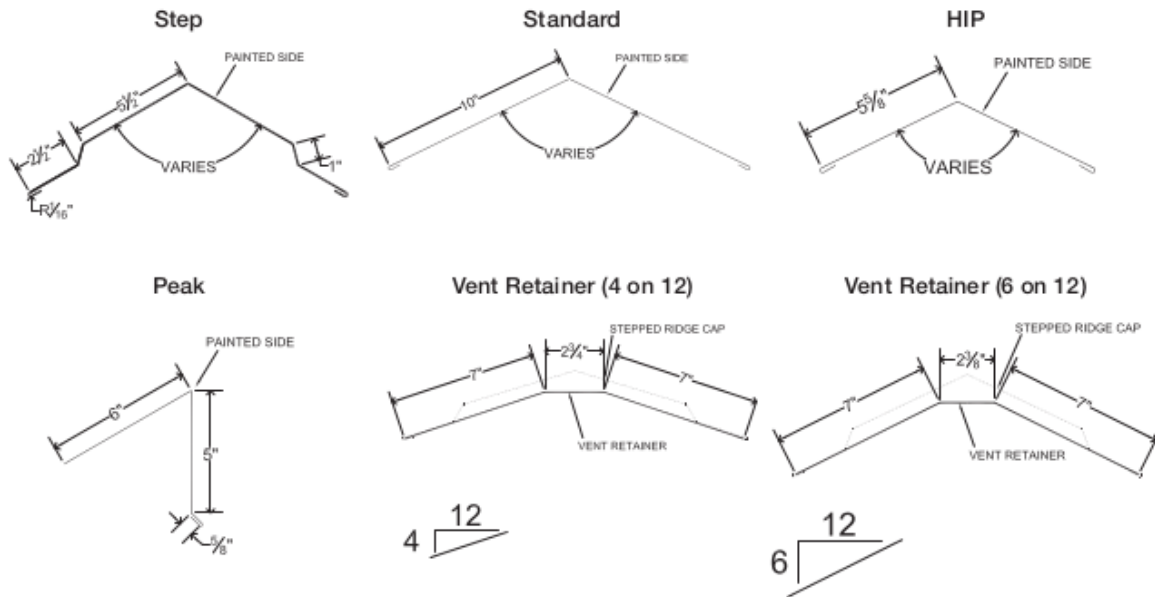

VALLEY

Standard Prefomed

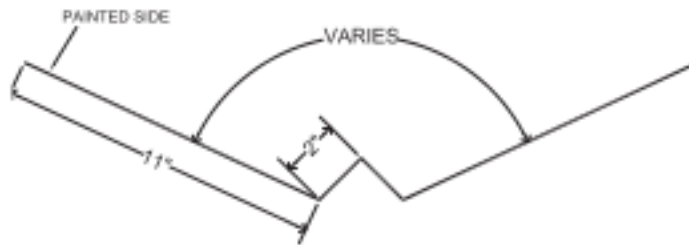

Extended Prefomed 26 GA



The difference in our Products is our Service

American Roofing Products - Standing Seam

All trim can be custom folded to your specifications - see your sales representative.

AmeriLoc-II Clip Attached Standard Trim

GABLE/RAKE

Standard

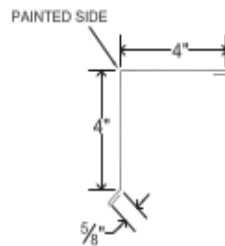

Step

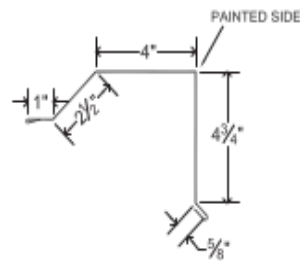

FLASHING

Reglet

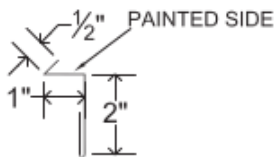

Counter

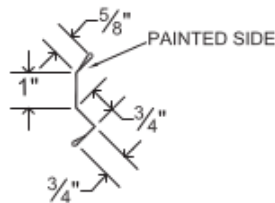

Transition

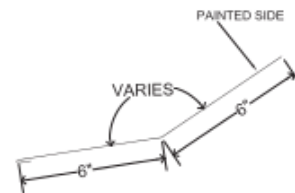

Gambrel

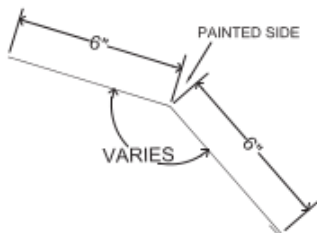

Sidewall

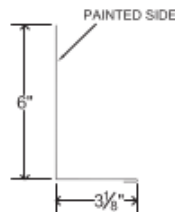

Step Sidewall

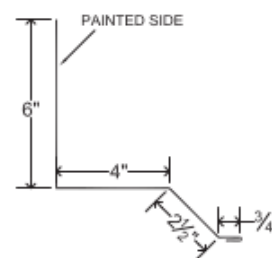

Endwall

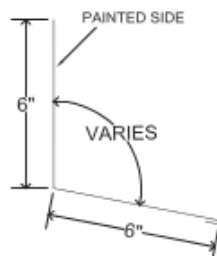

The difference in our Products is our Service



American Roofing Products - Standing Seam

All trim can be custom folded to your specifications - see your sales representative.

AmeriLoc-II Clip Attached Standard Trim

EAVE

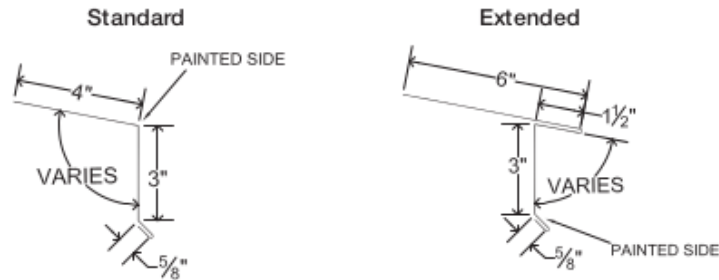

CLEATS

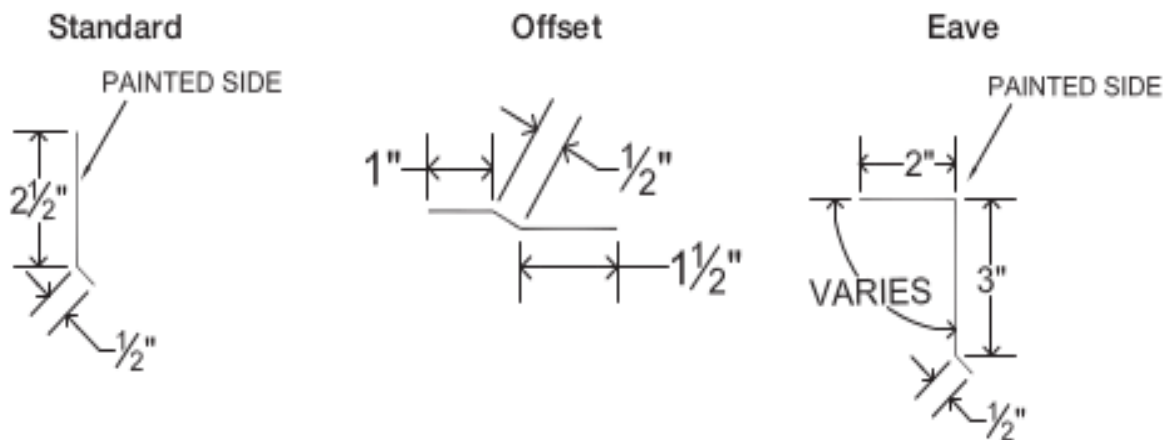

Z-CLOSURE

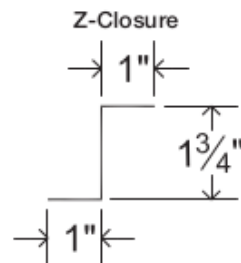

The difference in our Products is our Service

American Roofing Products - Standing Seam

All trim can be custom folded to your specifications - see your sales representative.

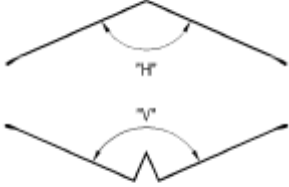
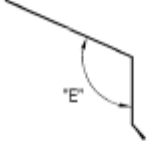
FLASHING ANGLE CHART					
RIDGE		HIP/VALLEY		EAVE	
					
ROOF PITCH	ANGLE "R"	ROOF PITCH	ANGLE "H" / "V"	ROOF PITCH	ANGLE "E"
1:12	170.5°	1:12	173.3°	1:12	94.8°
2:12	161.1°	2:12	166.6°	2:12	99.5°
3:12	151.9°	3:12	160.3°	3:12	104.0°
4:12	143.1°	4:12	154.2°	4:12	108.4°
5:12	134.8°	5:12	148.4°	5:12	112.6°
6:12	126.9°	6:12	143.1°	6:12	116.6°
7:12	119.5°	7:12	138.3°	7:12	120.3°
8:12	112.6°	8:12	133.8°	8:12	123.7°
9:12	106.3°	9:12	129.8°	9:12	126.9°
10:12	100.4°	10:12	126.2°	10:12	129.8°
11:12	95.0°	11:12	122.9°	11:12	132.5°
12:12	90.0°	12:12	120.0°	12:12	135.0°

Angle Chart

Use the chart at the left to determine necessary angles for trim.

The difference in our Products is our Service

